

SWAGTRON®

K1 Kid's Scooter



Quick Start Guide

BEFORE OPERATING THIS VEHICLE, PLEASE READ ALL INSTRUCTIONS. This guide will walk you through the functions, usage, and proper care of your SWAGTRON® K1 Kid's Scooter. If you have any questions or cannot find the information you need in the guide, please contact your place of purchase or our customer service at 1-844-299-0625.

1 Box Contents

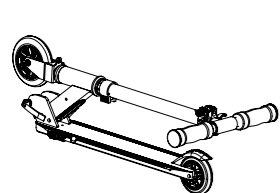

Scooter x 1



Allen Key x 1



Quick Start Guide x 1

2 Product Overview

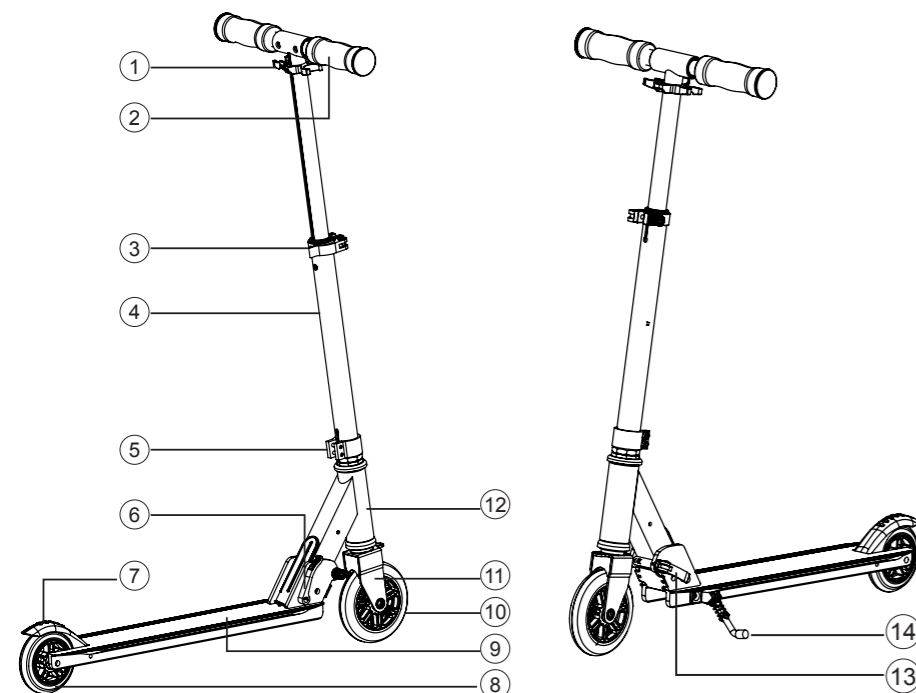

- ① Handle Fixture
- ② Handle
- ③ Upper Clamp
- ④ Stem
- ⑤ Lower Clamp
- ⑥ Folding Lever
- ⑦ Brake
- ⑧ Rear Wheel
- ⑨ Deck
- ⑩ Front Wheel

- ⑪ Fork
- ⑫ Steering Tube
- ⑬ Quick Lock
- ⑭ Kickstand

3 Before Riding Your Scooter

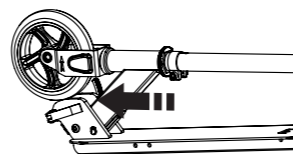

Figure 1

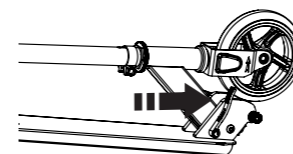

Figure 2

How to Unfold Your Scooter

- Open the Quick Lock at the side of the front wheel (Figure 1), push the Folding Lever forwards to unlock the scooter (Figure 2), then unfold the scooter.

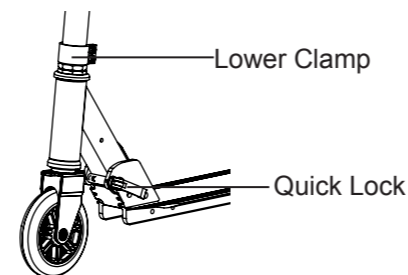

Figure 3

- Close the Quick Lock to secure the locking mechanism once the scooter is unfolded completely, then use the included Allen Key to tighten the screws until the Lower Clamp is closed (Figure 3).

Note: Always keep the end of Quick Lock parallel with the deck.

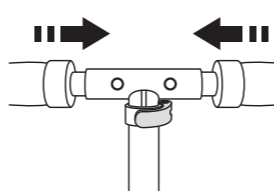

Figure 4

Adding the Handles

- Insert Handles into the Stem and make sure the metal pegs pop out to secure the Handles properly (Figure 4).

Adjust the Stem

- Open the Upper Clamp, press the metal peg in, and grasp the stem to raise or lower it to one of the 2 height levels.(Figure 5).
- To secure the Stem, make sure the metal peg pops out again. Close the Upper Clamp to secure the handlebars.

Note:

- * The metal peg MUST pop into one of the two designated holes in order for the scooter to be safe to ride.

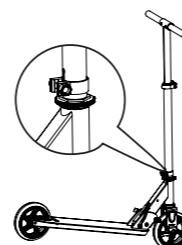

Figure 6

- * The screws in the Lower Clamp must not be taken out. If you lose the screws, do not use the scooter until the screws have been replaced (Figure 6).

4 Usage Instructions

How to Use Your Scooter



- Age-appropriate protective gear including an age-appropriate ASTM F1492 helmet, elbow pads, knee pads, and wrist guards must be worn at all times.
- The scooter supports up to 220 lbs (100kg).

You should equip children with suitable protective gear and use the scooter on level surfaces. For your safety, please carefully read this entire sections before attempting to ride. Use with adult supervision and inform your child of the following safety guidelines.

- Hold both handles firmly.
- Put one foot towards the front of the deck.
- With your other foot, push off the ground to propel the scooter forward.
- Both feet can fit on the deck when desired speed has been reached.
- To stop, step on the brake with your rear foot.

Practicing Guidelines

Practice until you are comfortable with using the scooter. See the following tips below.

- Wear casual clothing and flat shoes to maintain your flexibility and stability.
- Practice until you can easily get on, move forward, turn, stop, and dismount with ease.
- Make sure the pavement is even. Do not ride on a slope until you are experienced.
- The scooter is designed for relatively smooth, flat terrain. When riding on uneven terrain, slow down.
- Until you are comfortable using the scooter, avoid riding in places with pedestrians or obstacles.

Diagram of Standing and Folding

The scooter includes a kickstand. Before using it, bring the scooter to a complete stop. Before riding the scooter again, lean the scooter off the kickstand and push the kickstand up.

• Standing (Figure 7)

1. Locate the kickstand by the side of the deck.
2. Push the kickstand down and away from the scooter.
3. Lean the weight of the scooter onto the kickstand carefully.

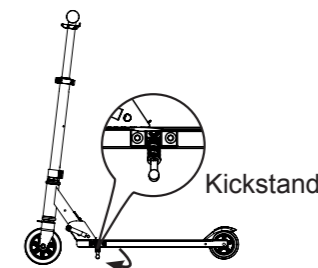

Figure 7

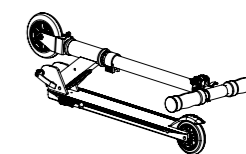

Figure 8

• Folding (Figure 8)

1. Push the Folding Lever forwards to unlock the system. If you cannot push the Folding Lever easily, please step on the deck and push the Stem slightly forwards before you push the Folding Lever.
2. Keep the system unlocked, then grasp the Stem firmly and pull it down until it and the deck are parallel.



- When folding the scooter, ensure that the front wheel is aligned to the scooter's body. If not, it will not fold properly. Keep fingers away from all moveable parts of the scooter to prevent injury to fingers or other body parts.
- Before moving, lifting, or otherwise transporting the scooter, fold the scooter and grasp it.

5 Safety Information

The SWAGTRON® K1 Kid's Scooter is a personal scooter designed for children ages 5 and up. By operating the scooter, the user acknowledges and accepts responsibility of all risks associated with the use of the SWAGTRON® K1 Kid's Scooter which may include, but are not limited to, muscle injuries, broken bones, lacerations, serious injury, and possible death.

- To better insure your safety, **ALWAYS USE APPROPRIATE PROTECTIVE GEAR**, read and follow all instructions and warnings in this guide.
- Appropriate protective gear should include an age-appropriate ASTM F1492 approved helmet, elbow pads, knee pads, and wrist guards.
- This is a self propelled scooter designed for a single rider only. It is not intended or equipped for road use, off road use or use with any motorized device.
- Use on flat, clean and dry surfaces, and keep away from other road users.
- Please add oil for lubrication periodically and replace bearings when worn.
- Use a few drops of oil to lubricate wheel bearings as needed.
- Clean bearings after use.
- Regular maintenance enhances the safety of equipment.
- Use the scooter at your own risk. We are not responsible for accidents due to product misuse.
- Please check all screws and fittings are secure before giving the scooter to a child.
- The scooter should be used with caution, since it requires skill and practice so, so as to avoid falls or collisions that may cause injury to the user or other parties.

6 Warnings



- Use with adult supervision.
- The braking mechanism may get hot from continuous use, do not touch the brake after it has been used.
- Keep fingers away from moving parts to avoid pinching and entrapment.
- Never allow more than one person at a time on the scooter.
- Never ride at night, obey all traffic and pedestrian regulations, and give right of way to pedestrians.
- Care should be taken when riding on wet pavement as braking and wheel traction may be reduced.
- Never leave your scooter unlocked and unattended.
- Do not modify the scooter or change the scooter in any way not outlined in these instructions.
- Screws and fixtures may loosen over time so please check and tighten periodically.

7 Warranty Information

Your SWAGTRON® K1 Kid's scooter ("Product") includes a One Year Limited Hardware Warranty ("Warranty"). The Warranty covers product defects in materials and workmanship under normal use. This Warranty is limited to residents of the United States and Canada only and is available only to original purchasers. This Warranty gives you specific legal rights and you may also have other rights which vary from state to state.

This Warranty starts on the date of your purchase and lasts for one year (the "Warranty Period"). The Warranty Period is not extended if the Product is repaired or replaced. We may change the availability of this limited warranty at our discretion, but any changes will not be retroactive.

Warranty services are provided by SWAGTRON®. If a hardware defect arises and a valid claim is received within the Warranty Period, at its option and to the extent permitted by law, SWAGTRON® will: (1) repair the hardware defect by using new or refurbished parts that are equivalent to new in performance and reliability; or (2) exchange the Product with a product that is new or refurbished which is substantially equivalent to the original product. This Warranty is for one replacement only of like-items and does not cover items out of production if the product is no longer made or stocked. This Warranty is not assignable or transferable. The original purchaser may call SWAGTRON's toll-free number at 1-844-299-0625 for service requests.

When a product or part is exchanged, any replacement item becomes your property and the replaced item becomes SWAGTRON's property. This warranty only covers technical hardware defectiveness during the warranty period and under normal use conditions. SWAGTRON® does not warrant uninterrupted or error-free operation of this Product.

This Warranty does not cover any damage due to: (a) transportation; (b) storage; (c) improper use; (d) failure to follow the product instructions or to perform any preventive maintenance; (e) modifications; (f) unauthorized repair; (g) normal wear and tear; or (h) external causes such as accidents, abuse, or other actions or events beyond our reasonable control.

Important: Do not disassemble the Product. Disassembling the Product will void this Warranty. Only SWAGTRON® or a party expressly authorized by SWAGTRON® should perform service on this Product.

DISCLAIMER OF WARRANTY: THE REMEDIES DESCRIBED ABOVE ARE YOUR SOLE AND EXCLUSIVE REMEDIES AND OUR ENTIRE LIABILITY FOR ANY BREACH OF THIS LIMITED WARRANTY. OUR LIABILITY SHALL UNDER NO CIRCUMSTANCES EXCEED THE ACTUAL AMOUNT PAID BY YOU FOR THE DEFECTIVE PRODUCT, NOR SHALL WE UNDER ANY CIRCUMSTANCES BE LIABLE FOR ANY CONSEQUENTIAL, INCIDENTAL, SPECIAL OR PUNITIVE DAMAGES OR LOSSES, WHETHER DIRECT OR INDIRECT.

SOME STATES DO NOT ALLOW THE EXCLUSION OR LIMITATION OF INCIDENTAL OR CONSEQUENTIAL DAMAGES, SO THE ABOVE LIMITATION OR EXCLUSION MAY NOT APPLY TO YOU.

THE DURATION AND REMEDIES OF ALL IMPLIED WARRANTIES, INCLUDING WITHOUT LIMITATION THE WARRANTIES OF MERCHANTABILITY AND FITNESS FOR A PARTICULAR PURPOSE ARE LIMITED TO THE DURATION OF THIS EXPRESS LIMITED WARRANTY.

8 Specifications

Item	Parameters
Material	Aluminum and Steel
Scooter Dimensions	28 x 13 x 38.2 in
Deck Dimensions	19.7 x 4 in
Handlebar Height	27 ~ 38.5 in
Diameter (Front Wheel)	120 mm
Diameter (Rear Wheel)	100 mm
Product Weight	~6.42 lbs
Maximum Load	220 lbs
Ages	5+
Certifications	ASTM F2264