

# SWAGTRON®

## USER MANUAL

Ver. 1.0 10/12/20

In order to continue serving our customers and providing the best products, our product information including our user manuals may receive updates from time to time. Please check our website for the latest user manuals and product materials.

**SWAGGER 7T**  
FOLDING ELECTRIC SCOOTER



Scan here to  
download the  
user manual



# PROTECT YOUR DOME

## HELMETS SAVE LIVES

Helmets can reduce 85% of critical head injuries.

Elbow pads can reduce 82% of elbow injuries.

Knee pads can reduce 32% of knee injuries.

From <https://www.ncbi.nlm.nih.gov/pubmed/2716781>

Always wear proper protective gear when riding. This includes knee and elbow pads and an age-appropriate helmet.

- Helmets should fit comfortably and snugly, covering the forehead but not hindering your field of vision.
- The helmet should have a chin strap and buckle to keep the helmet in place.
- The helmet should be made out of a hard, protective outer shell and an impact-absorbing inner layer at least 1/2-inch thick.
- The helmet should be approved by the U.S. Consumer Product Safety Commission (CPSC), the Snell Memorial Foundation, or the American Society for Testing and Materials (ASTM).



Thank you for your purchase of the Swagger 7T Folding Electric Scooter by SWAGTRON®!

The Swagger 7T takes the fun, power and performance of an electric scooter and tops it off with an extra bit of swag.

To ensure your safety and the safety of others, please read and follow the guidelines in this user manual carefully and thoroughly before and during riding.

If you have any questions regarding the Swagger 7T, contact us at 1-844-299-0625 for further assistance.

Happy Riding!

The SWAGTRON® Team

## TABLE OF CONTENTS

### Section 1

## GENERAL INFORMATION

- 1.1 Important Information . . . . . 01
- 1.2 Safety Warnings. . . . . 02
- 1.3 Disposal at End-of-Life . . . . . 03
- 1.4 FCC Information . . . . . 04

### Section 2

## PARTS & FEATURES

- 2.1 What's in the Box? . . . . . 05
- 2.2 Diagram . . . . . 06
- 2.3 Display Information . . . . . 07
- 2.4 Program Menu . . . . . 08

### Section 3

## FOLDING & ASSEMBLY

- 3.1 Assembling the Handlebars . . . . . 10
- 3.2 Standing, Folding & Unfolding the Scooter 10

### Section 4

## CHARGING

- 4.1 Charging the Battery . . . . . 12

- 4.2 Detaching the Battery . . . . . 13

- 4.3 Attaching the Battery. . . . . 13

### Section 5

## USAGE

- 5.1 How to Ride . . . . . 15

- 5.2 Practicing Guidelines . . . . . 17

- 5.3 A Note about Performance-Based Specs . 17

### Section 6

## MAINTENANCE

- 6.1 Cleaning. . . . . 18

- 6.2 Storage . . . . . 19

- 6.3 Transportation . . . . . 19

### Section 7

## SPECIFICATIONS

### Section 8

## 90-DAY LIMITED HARDWARE WARRANTY

## Section 1

# GENERAL INFORMATION

Before operating this vehicle, please read all instructions. This manual will guide you through the functions, usage, and proper care of your Swagger 7T Folding Electric Scooter. If you have any questions or cannot find the information you need in the manual, please contact your place of purchase or our customer service at 1-844-299-0625. Before contacting customer service, please have your purchase information ready as this may be needed during the call. This information may be recorded below.

**Date of Purchase:**

**Place of Purchase:**

**It is important that you follow all safety warnings that appear throughout this manual and exercise good judgment when using your Swagger 7T scooter. Consult this manual before you attempt to use your Swagger 7T.**

## 1.1 Important Information

Within this manual, “the Swagger 7T”, “your Swagger 7T”, “your scooter” and “the scooter” refer to the Swagger 7T Folding Electric Scooter. The Swagger 7T is a personal scooter that uses electrical power. By riding the Swagger 7T, the user acknowledges and accepts responsibility for all risks associated with the use of the Swagger 7T which may include, but are not limited to, muscle injuries, broken bones, lacerations, serious injury, and possible death.



To better insure your safety, **ALWAYS USE APPROPRIATE PROTECTIVE GEAR**, read and follow all instructions and warnings in the User Manual.



**Appropriate protective gear should include shoes, kneepads, elbow pads and an ASTM F1492 approved helmet.**

## 1.2 Safety Warnings

When reading this manual, note these icons:

-  Notes with this icon **MUST** be read, understood, and obeyed to prevent injury or damage, etc.
-  Notes with this icon include relevant information.
- 
  - Do not place the battery in fire or direct contact with flames, heat or sunlight.
  - Avoid using or storing the scooter and/or battery in environments with extreme temperatures, hot or cold. Using or storing the battery in extreme temperatures may cause it to become hot or break and/or reduce battery performance or life expectancy.
  - Do not subject the battery to strong impact, piercing damage, or shock.
  - **POTENTIAL SHOCK RISK.** Do not allow water and/or liquids to enter the scooter's electric parts. If cleaning is needed, dampen non-abrasive cloth with water or mild cleaner and wipe off the scooter.
  - Never submerge the scooter or any of the scooter's components.
  - Do not disassemble or modify the battery. Attempting to repair or modify your battery voids all warranties. Only authorized repair centers may open and service the battery.
  - If the device is to be used by children, the caregiver should explain the contents of the user manual to the children. The caregiver should provide adequate supervision to ensure that the device is being used as explained in the user manual.
  - Immediately discontinue use of the battery if, while using, charging, or storing the battery, the battery emits an unusual smell, feels hot, changes color, changes shape, or appears abnormal in any other way.
  - In the event that the battery leaks and its fluid gets into one's eye, do not rub the eye. Rinse well with water and immediately seek medical care.
  - Use only the charger provided with your scooter. If you have lost, misplaced, or damaged the charger, contact customer support to obtain a replacement.

- Do not continue charging the battery if it does not recharge within the specified charging time. Disconnect the scooter from the charging cable and contact customer service.
  - Keep your charging environment clean and dry at all times.
  - If the charging port is damp or has any liquid on it, DO NOT charge your scooter.
  - Avoid charging in extremely hot or extremely cold environments. Charging the battery in extreme temperatures may cause it to become hot or to break and/or reduce battery performance or life expectancy.
  - Do not discharge the battery using any device except for the Swagger 7T Folding Electric Scooter.
  - Devices are not intended for use at elevations greater than 2000m (6561.68 feet) above sea level.
  - Prolonged exposure to UV rays, rain, and the elements may damage the enclosure materials. Store indoors when not in use.
-  • **WARNING- RISK OF FIRE - No user serviceable parts**
- **AVERTISSEMENT - Risque d'incendie - Aucune des pièces ne peut être réparée par l'utilisateur**

### 1.3 Disposal at End-of-Life

This product must not be disposed of by incineration, landfilling, or mixing with household trash. Improper disposal of the battery contained within this product may result in the battery heating up, rupturing, or igniting which may cause serious injury. The substances contained inside the battery present chemical risks to the environment. The recommended disposal for any Swagger 7T Folding Electric Scooter at its end-of-life is to dispose of the entire unit at or through an e-waste recycling center, program, or facility. Local regulations and laws pertaining to the recycling and disposal of lithium-ion batteries and/or products containing them will vary according to country, state, and local governments. You must check laws and regulations corresponding to where you live in order to dispose of the battery and/or unit properly. It is the user's responsibility to dispose of their waste equipment properly in accordance with local regulations and laws.

For additional information about where you should drop off your batteries and electrical or electronic waste, please contact your local or regional waste management office, your household waste disposal service, or your point-of-sale.



## 1.4 FCC Information

### **DECLARATION OF CONFORMITY:**

This device complies with Part 15 of the FCC Rules.

Operation is subject to the following two conditions: (1) This device may not cause harmful interference, and (2) this device must accept any interference received, including interference that may cause undesired operation.

### **FCC RELATED INFORMATION:**

This equipment has been tested and found to comply with the limits for a Class B digital device, pursuant to Part 15 of the FCC Rules. These limits are designed to provide reasonable protection against harmful interference in a residential installation. This equipment generates, uses, and can radiate radio frequency energy and, if not installed and used in accordance with the instructions, may cause harmful interference to radio communications. There is, however no guarantee that interference will not occur in a particular installation. If this equipment does cause harmful interference to radio or television reception, which can be determined by turning the equipment off and on, the user is encouraged to try to correct the interference by one or more of the following measures:

- Reorient or relocate the receiving antenna.
- Increase the separation between the equipment and receiver.
- Connect the equipment into an outlet on a circuit different from that to which the receiver is connected.
- Consult the dealer or an experienced radio/TV technician for help.

The manufacturer is not responsible for any radio or TV interference caused by unauthorized modifications to this equipment. Such modifications could void the user's authority to operate the equipment.

## Section 2

# PARTS & FEATURES

Please read the user manual in its entirety before using the Swagger 7T so that you may fully understand its parts and functions and be able to operate it safely.

## 2.1 What's in the Box?

- 1x Allen Key
- 2x Handles
- 1x User Manual
- 1x Charger
- 1x Swagger 7T Folding Electric Scooter

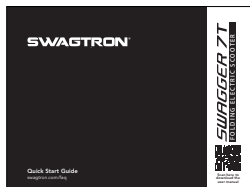

Quick Start Guide x 1

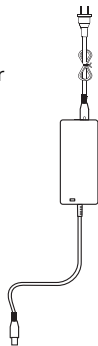

Charger x 1

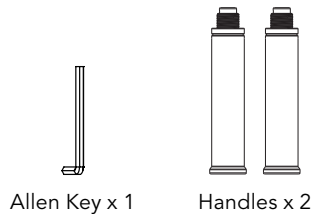

Allen Key x 1

Handles x 2

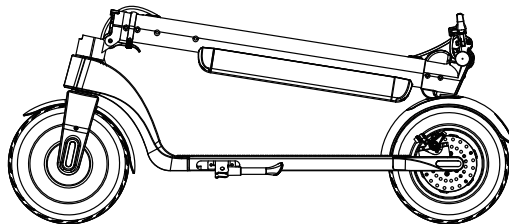

Swagger 7T Folding Electric Scooter

## 2.2 Diagram

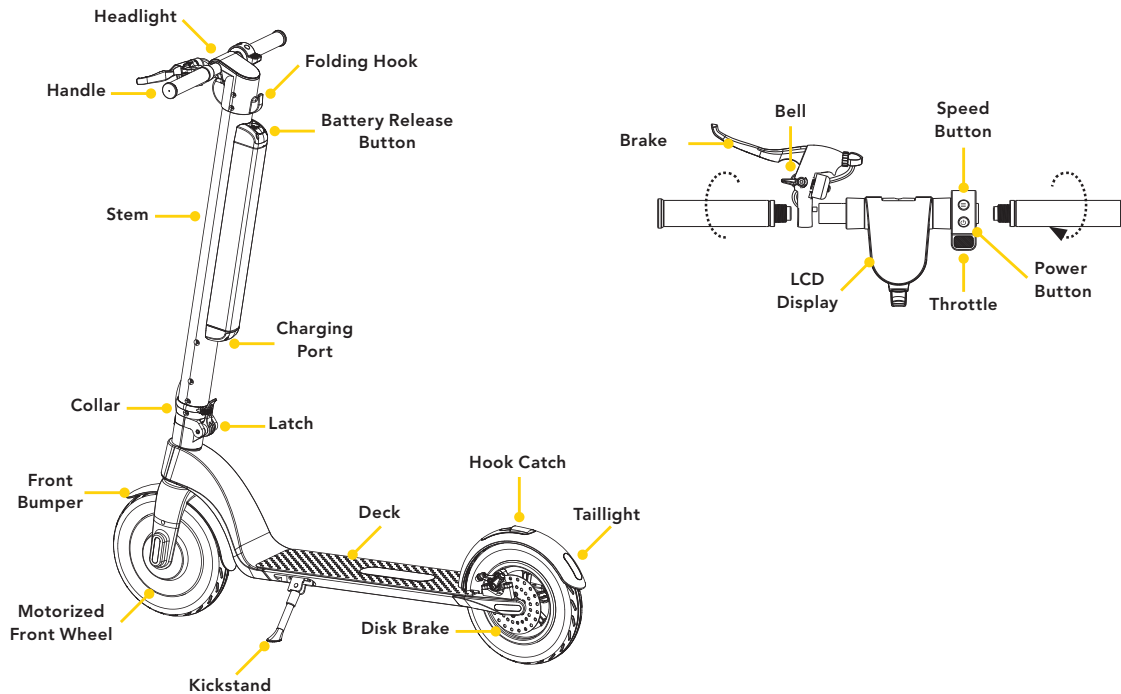

## 2.3 Display Information

The Swagger 7T's display can show a lot of information. Be sure you understand these before attempting to ride. Press and hold the power button approximately 2 seconds to turn the scooter on/off.

1. **Speedometer** - These numbers indicate the current speed and will change when the Swagger 7T is in use. Readings are measured in mph.
2. **Error Tips** - This icon appears if System diagnostics detects a malfunction. Contact the customer server for help.
3. **Battery Level Indicator** - This icon indicates how much battery life you have left.

**⚠ When the battery level is low, stop riding, turn off the scooter, and fully recharge it before riding again.**

4. **Speed measurement** - MPH (miles per hour).
5. **Speed measurement** - KM/H (kilometers per hour).
6. **Speed Mode (D)** - Displays the current speed mode (Beginner, Balanced, Sport). Each mode has its own maximum speed.

Top speed for Beginner (No D appears on the screen) is 6.2 mph.

Balanced (white D appears on the screen) is 9.3 mph.

Sport (Red D appears on the screen) is 15.5 mph.

**⚠ Refer to section 5.3 A Note about Performance-Based Specs with regard to top/max. speed.**

7. **Overheat Warning (🔥)** - This icon indicates the motor is overheating. If the motor overheats, the scooter will trigger warning alarms and this overheat icon (🔥) will display on the screen.

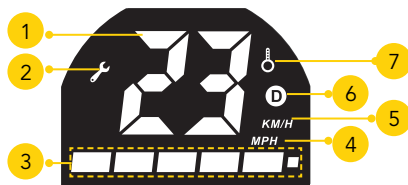

## 2.4 Program Menu

The display features five program settings which are not readily indicated on the screen by default. Follow the steps to access the settings screen and make changes.

- Step 1.** Press and hold the **SPEED** Ⓜ and **POWER** Ⓜ buttons simultaneously for ~2s to enter the main settings screen,
- Step 2.** Press the **SPEED** Ⓜ button to cycle between P0~P4 setting screens.
- Step 3.** Press the **POWER** Ⓜ button to confirm entering each setting screen.
- Step 4.** Press the **SPEED** Ⓜ button to cycle through options or levels according to which setting you are modifying.
- Step 5.** Press **POWER** Ⓜ button again to exit the current setting screen.
- Step 6.** To exit main settings screen, press and hold the **SPEED** Ⓜ and **POWER** Ⓜ buttons simultaneously for ~2s or wait. The display will time out and return to the main interface on its own.

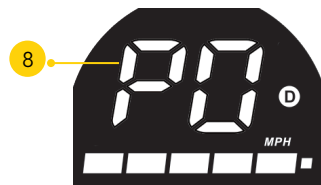

Main Settings Screen

### P0: Measurement Setting

This setting determines the unit of measurement in which your current speed is displayed. Speed may be displayed in either miles per hour (MPH) or kilometers per hour (KM/H). Option 0 is KM/H. Option 1 is MPH. By default, this option is set to 1. If changed, the display will show the related icons.

### P1: Cruise Control

Options can be set to 0 (off) or 1 (on). By default, this option is off. Selecting 1 turns the feature on.

- Ⓜ This feature will remain active until you turn it off from the Program Menu, even if you turn off the scooter.

### P2: Manual Kick-Start Motor

Options can be set to 0 (off) or 1 (on). By default, this option is off. Selecting 1 turns on this feature. When activated, the throttle can not be used until you reach 1.8 mph manually. If you drop below the trigger threshold, the throttle cannot engage again until you reach 1.8 mph.

 Using this feature could conserve battery power, improve battery life, and extend range-per-charge.

This feature will remain active until you turn it off from the Program Menu, even if you turn off the scooter.

### P3: Wheel Diameter Settings

This setting relates to wheel diameter and should display 10 inches by default. **Do not attempt to adjust this setting.**

### P4: Maximum Speed Limit Setting

This setting is for the maximum speed limited setting at Sport Mode (mode 3). There are three options here:

Option 1: 12.4 mph (20 km/h)

Option 2: 15.5 mph (25 km/h)

Option 3: FF (no limit)

Option 3 is the default setting.

 Refer to section 5.3 A Note about Performance-Based Specs with regard to top/max. speed.

### Section 3

## FOLDING & ASSEMBLY

Make sure the Swagger 7T is off before working with any of its parts. The scooter comes mostly assembled within the package. Some minor assembly is required before riding. All parts and tools are included.

### 3.1 Assembling the Handlebars

Before installing the handlebars, please check each for a small letter to indicate which side of the scooter the handle should be attached to. **L** is for the left side while **R** is for the right side. Screw in each handle and make sure everything is securely attached.

 When facing forward, screw the handles toward you to tighten.

### 3.2 Standing, Folding & Unfolding the Scooter

Before using the kickstand, bring the scooter to a complete stop and turn it off. Fold up the kickstand before riding the scooter again.

#### Standing

**Step 1.** Locate the kickstand on the side of the scooter's deck.

**Step 2.** Push the kickstand down and away from the scooter, then carefully lean the weight of the scooter onto the kickstand.

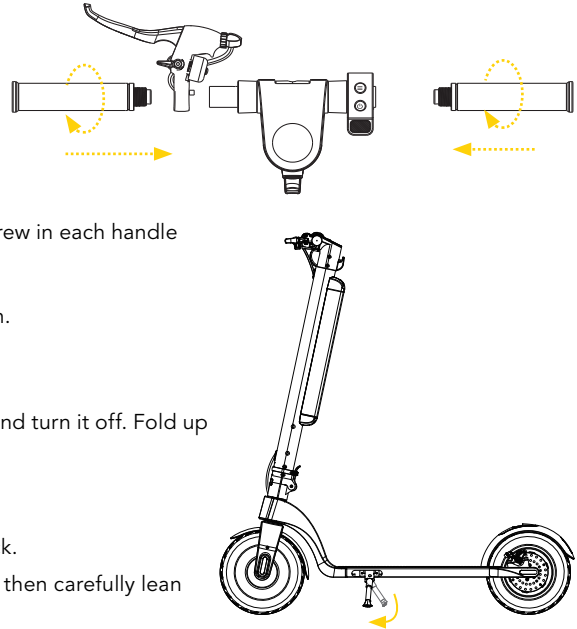

## Folding

- Step 1.** Turn the collar clockwise to unlock the latch.
- Step 2.** Fold the latch down then pull the stem down towards the deck.
- Step 3.** Line up the handlebars with the rear bumper so that the lock connects to the hook.

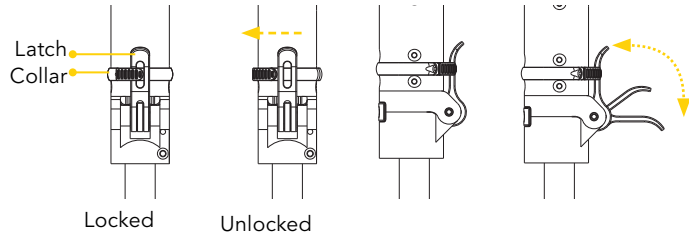

## Unfolding

- Step 1.** Push down the rear bumper to move the hook so that it detaches from the catch.
  - Step 2.** Pull the stem up away from the deck.
  - Step 3.** Fold the latch up towards the stem and turn the collar counter-clockwise to lock it.
- ⚠ Make sure the scooter is turned off before moving, lifting, or otherwise transporting the scooter.**

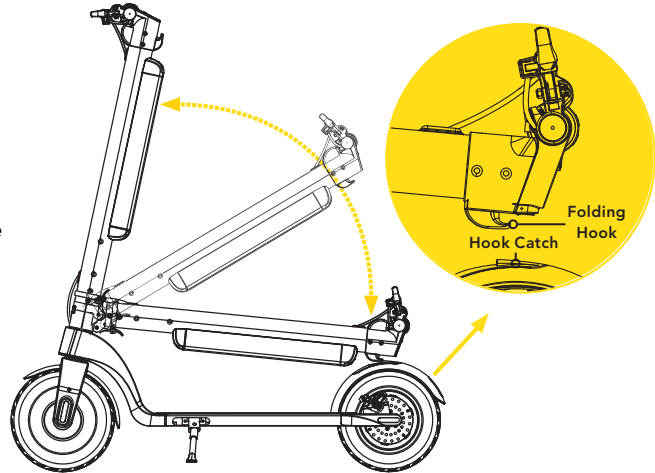



## CHARGING

**⚠** Charge the Swagger 7T before using it.

### 4.1 Charging the Battery

The charge cycle is complete when the battery indicator on display is full. Each charge cycle from zero to full charge will take 5~6 hours. When the backlit display on the handlebars indicates that battery power is low, recharge the Swagger 7T. Only use the included charger to recharge the Swagger 7T.

**📖** You can charge the Swagger 7T battery when it's installed in or detached from the scooter.

- Step 1.** Make sure the scooter is powered off. Then locate the charging port at the bottom of stem or the bottom of the battery if detached (see section **4.2 Detaching the Battery**).
- Step 2.** Plug the charger into a wall outlet (100V-240V) then plug the other end into the charging port. Remove the cap as needed.
- Step 3.** While the scooter is charging, the charger light will turn red.
- Step 4.** When the scooter is fully recharged, the charger light will turn green. You may then disconnect the scooter from the charger.

**⚠** **DO NOT**, under any circumstances, use the scooter while it is charging or connected to the charger.

**📖** The charging time is 5~6 hours. Charging longer than that may affect battery life and/or performance. If the charger's light doesn't turn on, it may not be fully connected. Check that it is securely connected to the wall and to the scooter.

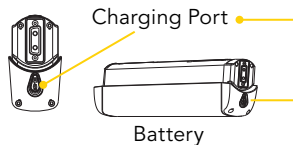
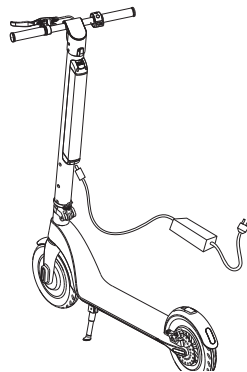

## 4.2 Detaching the Battery

For your convenience, the SG-7T's battery can be removed for easier charging and/or an extra measure of security.

- Press top of the battery release button and pull it away from the stem.
- While pulling the battery release button, pull the battery up along the stem from the compartment.
- Remove the battery completely.

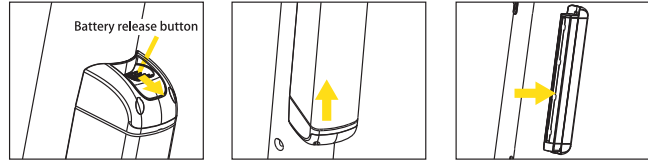

## 4.3 Attaching the Battery

- Insert the battery along the stem into the battery compartment.
- Line up the notch on the battery with the groove on the stem. Slide the battery up the stem slightly to make sure they are flush with no gap between them.
- Slide the battery down along the stem until it "clicks" into place in the battery compartment.

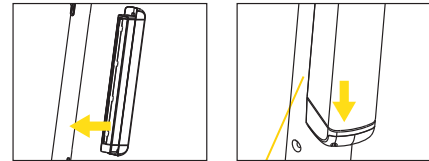
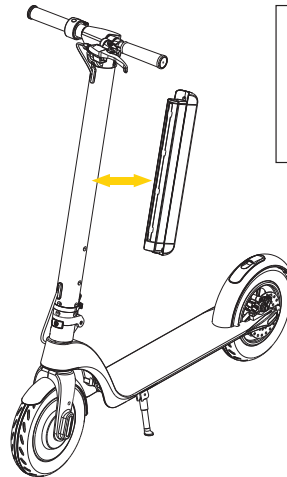



**⚠ Make sure there's no gap between stem and battery.**

Visit [www.swagtron.com](http://www.swagtron.com) to purchase additional Swagger 7T batteries.

## USAGE

We sincerely hope everyone rides can ride the Swagger 7T safely. Note the following information before attempting to ride your Swagger 7T.

-  • An ASTM F1492 approved helmet as well as other protective gear must be worn at all times
- The Swagger 7T supports up to 220 lbs (100 kg).
- Before each ride, check all cables for damage, and test the brakes. This is especially important if you might travel long distances. Do not ride if any part of the scooter is damaged or malfunctioning.
- Only operate the Swagger 7T where permitted. Local laws may restrict where you may ride.
- If the motor overheats, the safety feature will trigger automatically, the scooter will start alarm and the overheat icon () will display on LED display. Stop riding and allow ~15 minutes before using the motor again. In general, continuous uphill travel at 15° slopes for long periods of time is not recommended.
-  • The Swagger 7T contains a motor and may be classified as a motor vehicle under local laws in your area. It is your responsibility to understand and abide by any local laws restricting how or where you may ride.
- When the headlight is turned on, the taillight will stay on for increased visibility.

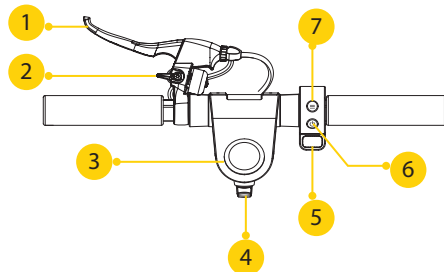

- |                |                 |
|----------------|-----------------|
| 1. Brake       | 6. Power Button |
| 2. Bell        | 7. Speed Button |
| 3. LED Display |                 |
| 4. Hook        |                 |
| 5. Throttle    |                 |

## 5.1 How to Ride

Assuming you are wearing suitable protective gear and that the Swagger 7T has been placed on a level surface, is charged, and does not have any issues, follow the steps below. For your safety, please read this entire section before attempting to ride.

- Start your scooter by pressing and holding the power button for ~2 seconds.
- Moving forward with your scooter is as easy as pressing the throttle or kicking off with your foot.
- Quick-press the speed button **twice** to turn the headlight on/off.
- Quick-press the speed button **once** to cycle through riding modes: Beginner, Balance and Sport.

Beginner Mode max. speed: 6.2 mph

Balanced Mode max. speed: 9.3 mph

Sport Mode max. speed: 17.4 mph (70kg).

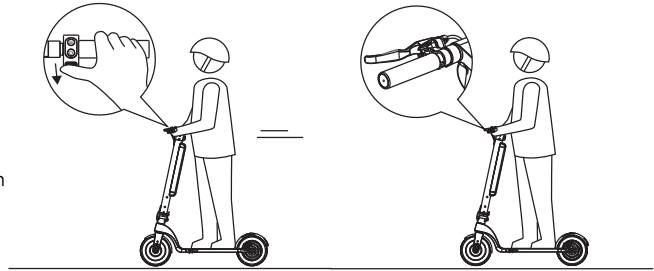

 **Riding speeds are approximate. Actual speed may vary due to terrain, rider weight, and/or other factors.**

 If the Swagger 7T is powered on and fully charged, but the throttle doesn't respond, the scooter may be in Kick-Start Mode (see **Manual (Kick-Start Motor)** section below).

- The LED display shows how much battery power is left.
- To slow down, ease off the throttle and apply gradual pressure to the brake.
- To stop, apply full pressure to the brake until the scooter stops completely.
- Use the bell to alert pedestrians and other riders of your presence.

### Manual (Non-Motorized)

- Step 1.** Carefully step on the scooter deck with one foot. Stand upright but relaxed and grab both handles.
- Step 2.** Keep one foot on the ground and kick off to begin accelerating manually. Use the handles to steer.
- Step 3.** To stop, use the brake to gradually coast to a stop then step off the scooter one foot at a time. Be extra cautious when dismounting for the first time. When using the brake, the taillight will turn red automatically.
- Step 4.** To turn the scooter off, press and hold the power button for ~2 seconds to turn off the scooter. The display and lights will turn off as the scooter powers off.

### Manual (Kick-Start Motor)

**Using this Manual Kick-Start Motor feature can conserve battery power, improve battery life, and extend range-per-charge.**

- Step 1.** Turn on the Manual Kick-Start Motor feature (see **Section 2.4 Program Menu**).
- Step 2.** Carefully step on the scooter deck with one foot. Stand upright but relaxed and grab both handles.
- Step 3.** Keep one foot on the deck and kick off to begin accelerating manually.
- Step 4.** Once you reach approx. 1.8 mph, the throttle will activate. Press the throttle to accelerate to the desired speed.
- Step 5.** To stop, release the throttle and use the brake to gradually coast to a complete stop. When using the brake, the taillight will turn red automatically.



**Dismount one foot at a time. Be extra cautious when dismounting for the first time.**



**This feature remains active until you manually turn it off in the Program Menu (see Section 2.4 Program Menu), even if you power off the scooter.**

## Cruise Control

**Step 1.** Turn on Cruise Control (see **Section 2.4 Program Menu**).

**Step 2.** Accelerate to reach the desired speed.

**Step 3.** Hold the throttle for approx. 6 seconds to turn on Cruise Control and maintain speed.

**Step 4.** Using the throttle or the brake will turn off Cruise Control.

**⚠ This feature remains active until you manually turn it off in the Program Menu (see Section 2.4 Program Menu), even if you power off the scooter.**

## 5.2 Practicing Guidelines



Practice until you are comfortable with using all of the scooter's functions. See the following tips below.

- Wear casual clothing and flat, closed-toe shoes to maintain your flexibility and stability.
- Practice until you can easily get on, move forward, turn, stop, and dismount with ease.
- Make sure the pavement is even. Do not operate on a slope until you are experienced.
- The Swagger 7T is designed for relatively smooth, flat terrain. When driving on uneven terrain, slow down.
- Until you are comfortable using the scooter, avoid operating in places with pedestrians or obstacles.

## 5.3 A Note about Performance-Based Specs

- Performance-based specs, including top speeds and miles per charge, may vary from rider to rider. It is based on a number of assumptions (rider weight, pavement type, proper tire inflation, etc.) all of which can have an impact on performance.
- Listed performance specs are based primarily on rider weight of 155 lb. (70 kg).

## MAINTENANCE

-  • **Do not perform any maintenance when the power is on, or the battery is charging. Do not let water or liquids get into the scooter as this will cause permanent damage to the electronic components.**
- **After each ride, especially if you have traveled a long distance, inspect your scooter.**
  1. Inspect the brake to make sure it's working properly.
  2. Make sure all screws and bolts are taut and properly fastened to prevent injury and unnecessary wear and tear.
-  • **For questions, concerns, or part replacement, please contact customer service.**

### 6.1 Cleaning

The Swagger 7T may need cleaning after riding for extended periods of time. Follow the tips below.

- Completely power off the scooter before cleaning.
- Use dry, non-abrasive cloth to gently remove debris or dust.
- If needed, dampen cloth with water or a mild cleaner and wipe off the scooter.
- Never use alcohol or ammonia-based cleaning solutions.
- Never spray liquid directly onto any part of the scooter.
- Do not allow any type of liquid to come in contact with the scooter's electronic parts.

## 6.2 Storage

- Before storing the scooter, fully charge it to prevent battery over-discharge due to inactivity.
- If storing the scooter for long periods, discharge and recharge the battery every three months.
- Cover the scooter to protect it from dust. Do not store in a dusty environment as, with all electronic devices, this may cause damage over time.
- DO NOT store the scooter in an unheated garage, shed, or any location with extreme temperature fluctuations. Store only in environments where temperatures will be stable and kept between -4°F to 140°F (-20°C to 60°C).

## 6.3 Transportation

Before moving, lifting, or otherwise transporting the scooter, turn it off. Fold the scooter (see **Section 3.2** for instructions) and pull the scooter along as you move it if needed.

- ⓘ **The Swagger 7T weighs approximately 30.86lb. (14kg). If you are unsure of your ability to lift this weight, please use both hands or have a second person help when lifting the scooter.**



## Section 7

**SPECIFICATIONS**

Indicators	Items	Parameters
Dimensions	Opened	42.63 x 16.14 x 45.66 in. (1090 x 410 x 1160 mm)
	Folded	42.9 x 16.14 x 17.9 in. (1090 x 410 x 455 mm)
Weight	Vehicle Weight	30.86 lb. (14 kg)
Materials	Frame	Aircraft-grade aluminum alloy
	Tires	Airless honeycomb, rubber
Requirements	Suitable Rider Height	4' - 6'6" (120 - 200 cm)
	Weight Capacity	44 - 265 lb. (20 - 120 kg)
	IP Rating	IP54
	Working Temp.	32°F to 109°F (0°C to 43°C)
	Storage Temp.	-4°F to 140°F (-20°C to 60°C)
Performance	Max. Speed*	17.4 mph (28 km/h)
	Max. Climbing*	10° without run-up, 15° with run-up
	Range per Charge*	19.9 miles (32 km) @ 70kg / 15.5 miles (25 km) @ 80kg
	Brakes	Electronic, Rear friction, "Autoguard"

\* Specs provided here assume an average rider weighing approx. 155 lb. (70 kg) riding on flat, even pavement. Performance will vary according to a number of factors, including riding style, rider weight and terrain conditions.

Indicators	Items	Parameters
Wheels	Wheel Type	Motorized (front), Passive (rear)
	Wheel Size	10 in.
Motor	Wattage (Rated)	350W
	Wattage (Max)	450W
Power	Battery Type	Lithium-ion (rechargeable), removable
	Battery Dimension	18.3 x 2.0 x 3.7 in. (465 x 50 x 95 mm)
	Battery Weight	6.2 lb. (2.8 kg)
	Battery Management	Automatic shutoff, Overcharging, Under-voltage, Overheating
	Voltage	36V 10Ah
	Charging Time	5~6 hours
Charger	Model	XHK-800-4220
	Input Voltage	100-240V 50/60Hz 2.0A(Max.)
	Output Voltage	42V 2.0A ⊖—⊕
	Manufactured By	Shenzhen Xin Heng tyco Electronics Co., Ltd 4F, B Building Thai Pine industrial zone. The New Road number91, Wave Street, Long hua new District Shenzhen, China.

## Section 8

### **90-DAY LIMITED HARDWARE WARRANTY**

Your SWAGTRON® Swagger 7T Folding Electric Scooter ("Product") includes a 90-Day Limited Hardware Warranty ("Warranty"). The Warranty covers product defects in materials and workmanship under normal use. This Warranty is limited to residents of the United States (Excluding Hawaii, Alaska and US Territories) and Canada only and is available only to original purchasers. This Warranty gives you specific legal rights and you may also have other rights which vary from state to state.

This Warranty starts on the date of your purchase and lasts for ninety (90) days ("Warranty Period"). The Warranty Period is not extended if the Product is repaired or replaced. We may change the availability of this limited warranty at our discretion, but any changes will not be retroactive.

Warranty services are provided by SWAGTRON®. If a hardware defect arises and a valid claim is received within the Warranty Period, at its option and to the extent permitted by law, SWAGTRON® will: (1) repair the hardware defect by using new or refurbished parts that are equivalent to new in performance and reliability; or (2) exchange the Product with a product that is new or refurbished which is substantially equivalent to the original product. This Warranty is for one replacement only of like-items and does not cover items out of production if the product is no longer made or stocked. This Warranty is not assignable or transferable. The original purchaser may call SWAGTRON's toll-free number at 1-844-299-0625 for service request.

When a product or part is exchanged, any replacement item becomes your property and the replaced item becomes SWAGTRON's property. This warranty only covers technical hardware defectiveness during the warranty period and under normal use conditions. SWAGTRON® does not warrant uninterrupted or error-free operation of this Product. Return shipping shall only be provided for Products dead on arrival ("DOA") within 30 days of purchase only. All other returns/repairs shall require payment of shipping cost at discounted rate to be determined as follows:

SWAGTRON® E-Scooters, and Hoverboards shall be Twenty Dollars (\$20)\*\*  
\*\*shipping prices are subject to change without further notice.

This Warranty does not cover any damage due to: (a) transportation; (b) storage; (c) improper use; (d) failure to follow the product instructions or to perform any preventive maintenance; (e) modifications; (f) unauthorized repair; (g) normal wear and tear( including but not limited to wearables and other consumable parts such as tires); or (h) external causes such as accidents, abuse, or other actions or events beyond our reasonable control.

Important: Do not disassemble the Product. Disassembling the Product will void this Warranty. Only SWAGTRON® or a party expressly authorized by SWAGTRON® should perform service on this Product.

DISCLAIMER OF WARRANTY: THE REMEDIES DESCRIBED ABOVE ARE YOUR SOLE AND EXCLUSIVE REMEDIES AND OUR ENTIRE LIABILITY FOR ANY BREACH OF THIS LIMITED WARRANTY. OUR LIABILITY SHALL UNDER NO CIRCUMSTANCES EXCEED THE ACTUAL AMOUNT PAID BY YOU FOR THE DEFECTIVE PRODUCT, NOR SHALL WE UNDER ANY CIRCUMSTANCES BE LIABLE FOR ANY CONSEQUENTIAL, INCIDENTAL, SPECIAL OR PUNITIVE DAMAGES OR LOSSES, WHETHER DIRECT OR INDIRECT.

SOME STATES DO NOT ALLOW THE EXCLUSION OR LIMITATION OF INCIDENTAL OR CONSEQUENTIAL DAMAGES, SO THE ABOVE LIMITATION OR EXCLUSION MAY NOT APPLY TO YOU.

THE DURATION AND REMEDIES OF ALL IMPLIED WARRANTIES, INCLUDING WITHOUT LIMITATION THE WARRANTIES OF MERCHANTABILITY AND FITNESS FOR A PARTICULAR PURPOSE ARE LIMITED TO THE DURATION OF THIS EXPRESS LIMITED WARRANTY.

**SWAGTRON®**

Copyright © 2020 SWAGTRON. All rights reserved.